



KARIN VX TANDEM HORIZONTAL



**EUROPEAN
WARRANTY**

MATERIAL:

- Vertical collectors in painted mild steel \varnothing 1,2 inch.
- Double row of rectangular horizontal heating elements in painted mild steel 0,6x0,8 inch.

FIXING KIT:

Brackets, airvent, hexagonal tool, plugs and screws for mounting suitable for use on compact or hollow brick, user notice. The fixing kit is compliant with VDI 6036 norm, class 4.

PACKAGING:

Carton angular and profiles protected by a recyclable film in polyethylene. User notice included.

PAINTING PROCESS:

Painted with ecological epoxy powders (Certificate DIN 55900-1;-2).

COLOURS:

See colour chart.

ACCESSORIES:

For the complete list, please refer to the accessories chapter.

Width L [in]	19,7	23,6	31,5	39,4	47,2	55,1	59,1	63,0	66,9
Dry Weight per section [lbs]	1,35	1,60	2,09	2,59	3,08	3,57	3,82	4,07	4,31
Element water content [gal]	0,07	0,08	0,10	0,12	0,15	0,17	0,18	0,19	0,21
Element surface [Sq ft ²]	0,81	0,96	1,26	1,56	1,86	2,16	2,31	2,46	2,62
Pipe centres I [in] (H1 only)	18,5	22,4	30,3	38,2	46,1	53,9	57,9	61,8	65,7

For output at different ΔT , please refer to the following formula: $\text{desired output} = \text{output at } \Delta T 50 \times (\text{desired } \Delta T / 50)^n$

Width L [in]	70,9	74,8	78,7	86,6	90,6	98,4
Dry Weight per section [lbs]	4,56	4,81	5,06	5,30	5,55	5,80
Element water content [gal]	0,22	0,23	0,24	0,25	0,27	0,28
Element surface [Sq ft ²]	2,77	2,92	3,07	3,22	3,37	3,52
Pipe centres I [in] (H1 only)	69,7	73,6	77,6	85,4	89,4	97,2

P. Max: 8 bar

T. Max: 230° F

Functioning: hot water

Connections: n° 2 x 1/2" G - 1 x 1/2" G

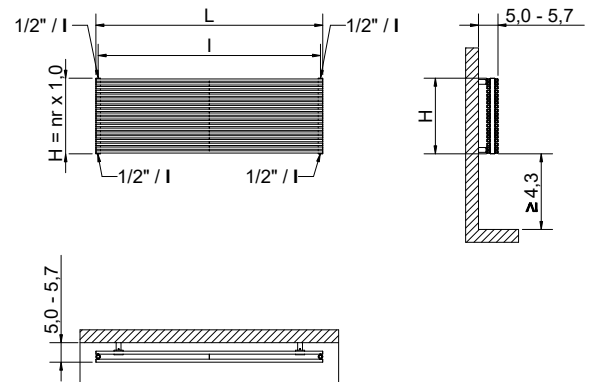

Quotes for Kristal valves

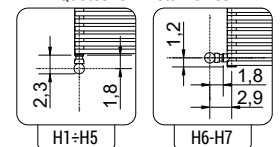

STANDARD CONNECTIONS WITHOUT SURCHARGE

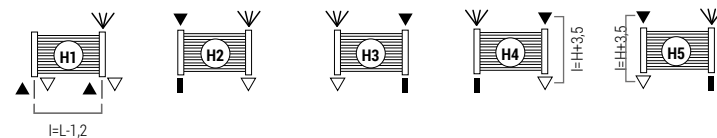

LEGENDA: In Out airvent H Height I pipe centres L width connection welded cap

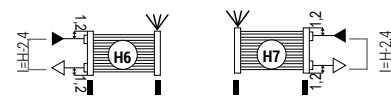

SPECIAL CONNECTIONS



Always specify the kind of connection needed when ordering.
Bidirectional pipe connection not available

ACCESSORIES

If ordered separately from the radiator, the accessories are available in standard white only

 <p>Kristal valve square with thermostatic option white R01 Copper conn. \varnothing 12/14/15 Art. nr. 5991990311161 Multilayer conn. \varnothing 16 Art. nr. 5991990311160</p>	 <p>Kristal valve corner right with thermostatic option white R01 Copper conn. \varnothing 12/14/15 Art. nr. 5991990311176 Multilayer conn. \varnothing 16 Art. nr. 5991990311175</p>	 <p>Pair of white tube cover kit Art. nr. 5103000000060</p>
---	---	---

Art. nr. are referred to colour WHITE R01

KARIN VX TANDEM HORIZONTAL

Width L [in]		19,7	23,6	31,5	39,4	47,2	55,1	59,1	63,0	66,9	OUTPUT PER LINE- AR METER		Exp. n
Height H [in]	N° El.	Btu $\Delta t=122^{\circ}\text{F}$	Btu $\Delta t=122^{\circ}\text{F}$	Btu $\Delta t=122^{\circ}\text{F}$	Btu $\Delta t=122^{\circ}\text{F}$	Btu $\Delta t=122^{\circ}\text{F}$	Btu $\Delta t=122^{\circ}\text{F}$	Btu $\Delta t=122^{\circ}\text{F}$	Btu $\Delta t=122^{\circ}\text{F}$	Btu $\Delta t=122^{\circ}\text{F}$	Btu $\Delta t=86^{\circ}\text{F}$		
7,9	8	1003	1204	1607	2010	2412	2812	3013	3214	3416	1082	1,2131	
9,8	10	1184	1419	1894	2368	2842	3317	3552	3787	4026	1276	1,2112	
11,8	12	1348	1614	2153	2692	3231	3770	4040	4306	4576	1450	1,2093	
13,8	14	1495	1791	2388	2986	3583	4180	4480	4777	5077	1634	1,1803	
15,7	16	1628	1952	2600	3252	3903	4552	4879	5204	5528	1771	1,1887	
17,7	18	1747	2095	2795	3494	4194	4890	5241	5589	5941	1897	1,1970	
19,7	20	1856	2228	2969	3712	4456	5197	5569	5941	6312	2006	1,2054	
21,7	22	1955	2348	3129	3910	4692	5473	5865	6254	6647	2109	1,2081	
23,6	24	2044	2453	3272	4088	4907	5722	6132	6541	6951	2204	1,2109	
25,6	26	2126	2549	3398	4248	5098	5947	6374	6797	7224	2286	1,2137	
27,6	28	2197	2634	3515	4391	5268	6149	6589	7026	7466	2426	1,1624	
29,5	30	2262	2713	3617	4521	5425	6330	6783	7234	7688	2508	1,1543	
31,5	32	2317	2781	3706	4634	5562	6486	6951	7415	7879	2580	1,1462	
33,5	34	2368	2839	3787	4733	5678	6626	7101	7572	8046	2648	1,1380	
35,4	36	2412	2893	3856	4821	5787	6749	7234	7715	8196	2709	1,1299	
37,4	38	2450	2938	3917	4896	5876	6855	7346	7834		2764	1,1218	
39,4	40	2484	2979	3972	4965	5958	6951	7449			2740	1,1637	
41,3	42	2511	3013	4016	5019	6022	7026	7531			2781	1,1556	
43,3	44	2532	3037	4050	5064	6077	7090				2801	1,1597	
45,3	46	2556	3068	4088	5111	6132					2853	1,1393	
47,2	48	2576	3091	4122	5152	6183					2880	1,1312	
49,2	50	2597	3115	4153	5193	6231					2928	1,1231	
51,2	52	2614	3139	4183	5231	6275					2958	1,1149	
53,1	54	2634	3160	4214	5268						2992	1,1068	
55,1	56	2655	3184	4248	5309						3030	1,0987	
57,1	58	2675	3211	4282	5350						3064	1,0906	
59,1	60	2699	3238	4320	5398						3105	1,0824	
61,0	62	2726	3269	4361	5449						3149	1,0743	
63,0	64	2754	3306	4408	5511						3197	1,0662	
65,0	66	2788	3347	4463	5579						3248	1,0581	
66,9	68	2829	3395	4524	5657						3310	1,0499	
68,9	70	2873	3446	4596	5746						3375	1,0418	
70,9	72	2924	3508	4678	5845						3446	1,0337	

All intermediate sizes are available for widths from 8 to 72 elements and heights from 19,7 to 98,4 inch

Width L [in]		70,9	74,8	78,7	86,6	90,6	98,4	OUTPUT PER LINE- AR METER		Exp. n
Height H [in]	N° El.	Btu $\Delta t=122^{\circ}\text{F}$	Btu $\Delta t=122^{\circ}\text{F}$	Btu $\Delta t=122^{\circ}\text{F}$	Btu $\Delta t=122^{\circ}\text{F}$	Btu $\Delta t=122^{\circ}\text{F}$	Btu $\Delta t=122^{\circ}\text{F}$	Btu $\Delta t=86^{\circ}\text{F}$		
7,9	8	3617	3818	4020	4422	4620	5023	1082	1,2131	
9,8	10	4262	4501	4736	5210	5446	5920	1276	1,2112	
11,8	12	4845	5115	5384	5923	6193	6732	1450	1,2093	
13,8	14	5374	5674	5971	6568	6869	7466	1634	1,1803	
15,7	16	5855	6179	6504	7155	7479	8131	1771	1,1887	
17,7	18	6289	6637	6988	7688	8036	8735	1897	1,1970	
19,7	20	6681	7053	7425	8169	8537	9281	2006	1,2054	
21,7	22	7039	7428	7821	8602	8994	9776	2109	1,2081	
23,6	24	7360	7769	8175	8994	9404	10223	2204	1,2109	
25,6	26	7650	8073	8500	9349	9772		2286	1,2137	
27,6	28	7906	8343	8783	9660			2426	1,1624	
29,5	30	8138	8592	9042				2508	1,1543	
31,5	32	8339	8803					2580	1,1462	
33,5	34	8520						2648	1,1380	

ARDESIA®

TOWEL RAILS

ELECTRIC

STAINLESS STEEL

RADIATORS

VENTILATION
RADIATORS

MY WAY®
ACCESSORIES AND
TECHNICAL SUPPORT